

Benennung:
 ACO Stormbrunn Grundelement aus Polypropylen (PP)
 H=914 mm SD, 1,2 x 0,6 x 0,494 m
 Art.-Nr. 314.090

Technische Änderungen vorbehalten

Datum	Name
Gez. 05.09.2017	debeling
Upd.	
Norm	

ACO Tiefbau Vertrieb GmbH
 24555 Neudorf, Postfach 330
 Tel. 04397 361-590
 Fax 04397 361-339
 www.aco-tiefbau.de

Zeichnung-Nr.
 G1-M01-1610-3

Index
 000

Schutzvermerk gemäß DIN 34

Ers. für:

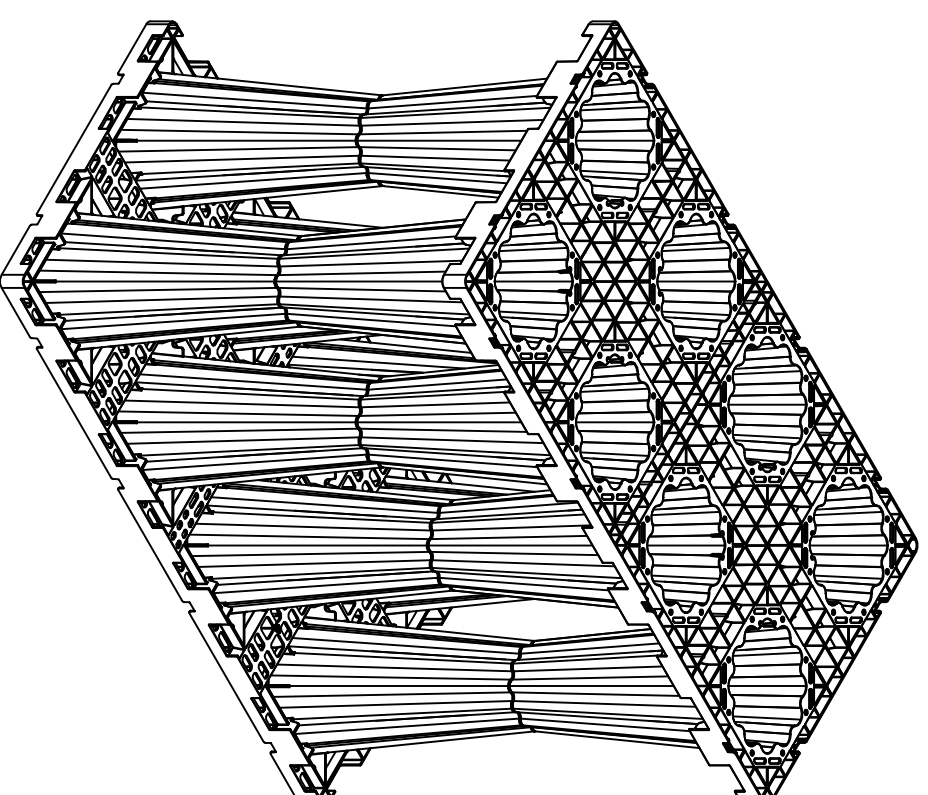
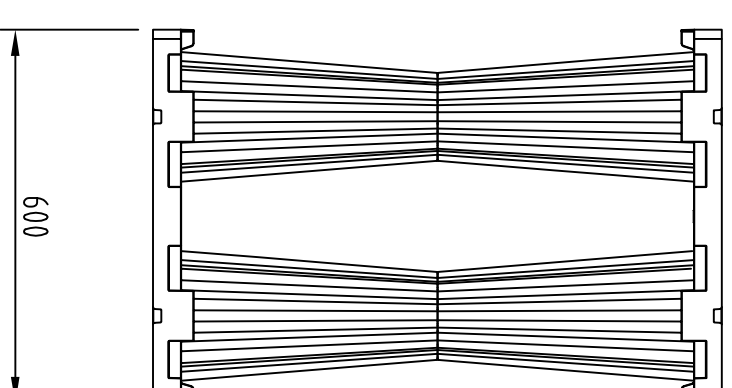
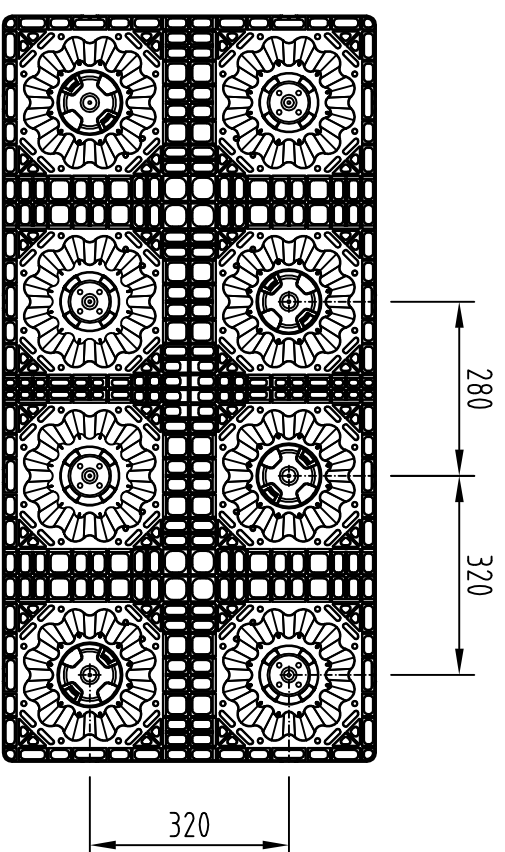
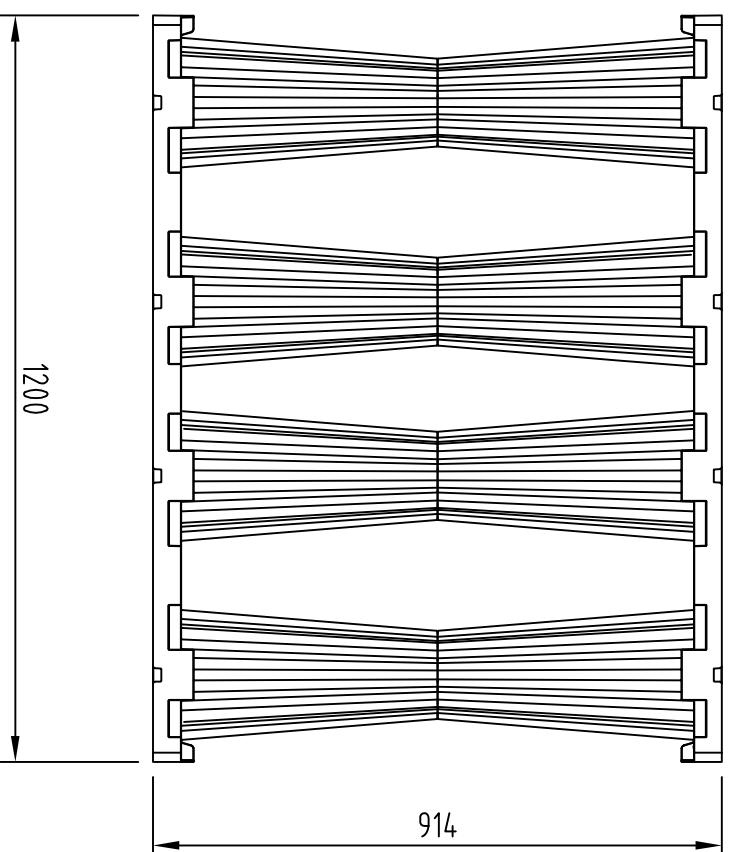

Benennung:
 ACO Stormbrixx 914 SD, Grundelement
 1,2 x 0,6 x 0,914 m
 Art.-Nr. 314.090

Technische Änderungen vorbehalten

Datum	Name
17.07.2017	skarthik
Gez.	
Upd.	
Norm	

 ACO Tiefbau ACO Tiefbau Vertrieb GmbH 21255 Rendsburg, Postfach 320 Tel. 04331 / 354-500 FAX 04331 / 354-358 www.aco-tiefbau.de	
Zeichnung-Nr.:	G1-M01-XXXX-X
Ers. für:	
Index	000

Schutzvermerk gemäß DIN 34

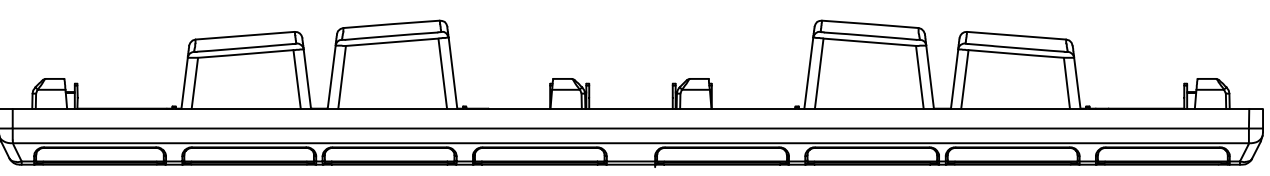
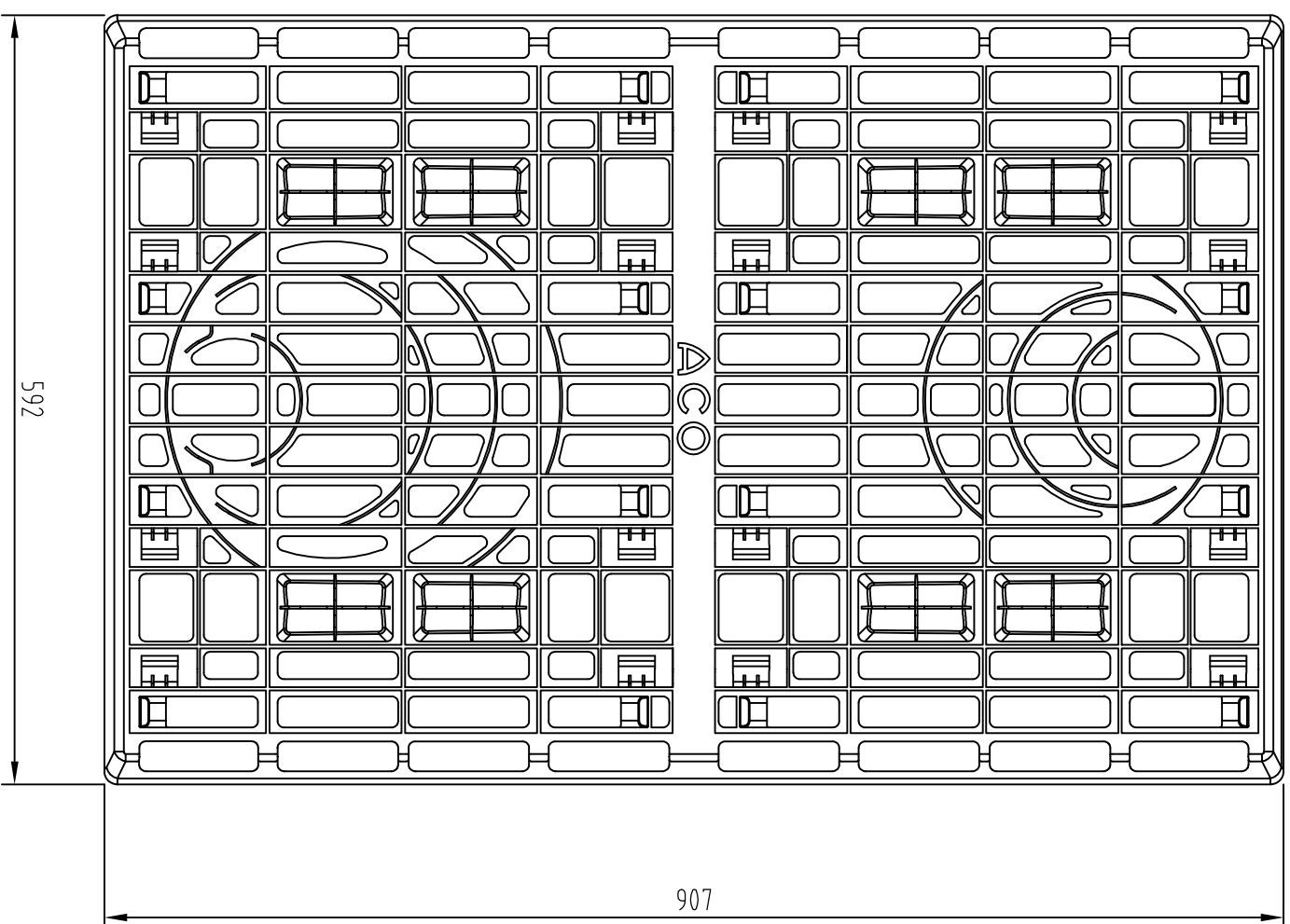

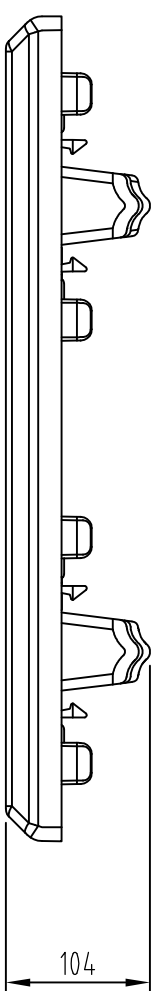
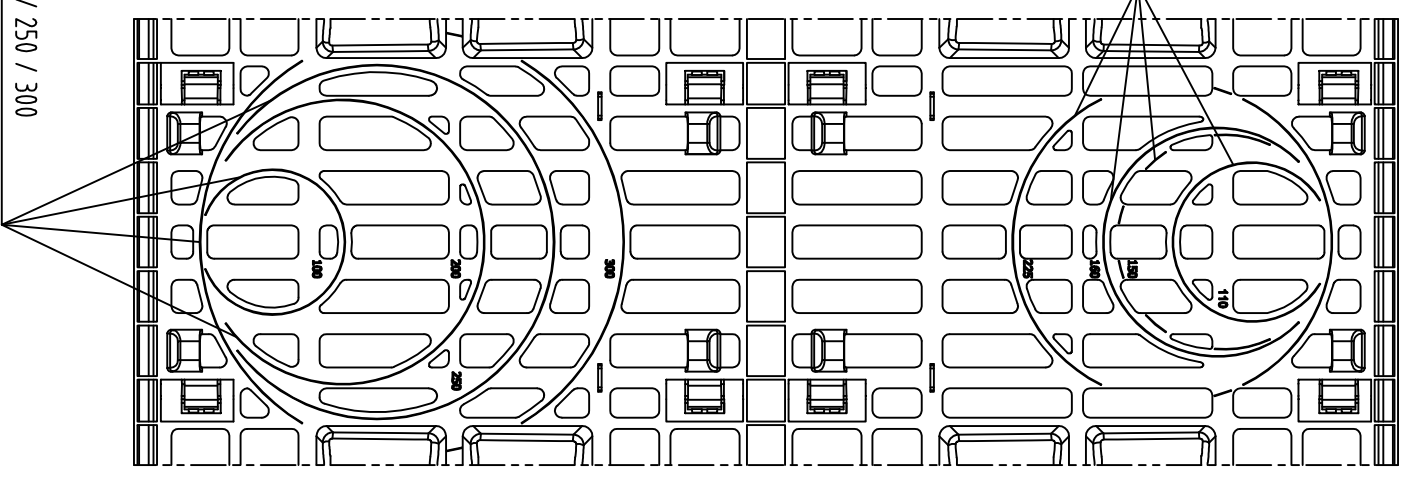

Markierungen der Ausschnitt-
möglichkeiten für DN/OD 100 / 200 / 250 / 300

Markierungen der Ausschnitt-
möglichkeiten für DN/OD
110 / 150 / 160 / 225 auf der
Rückseite der Seitenwand

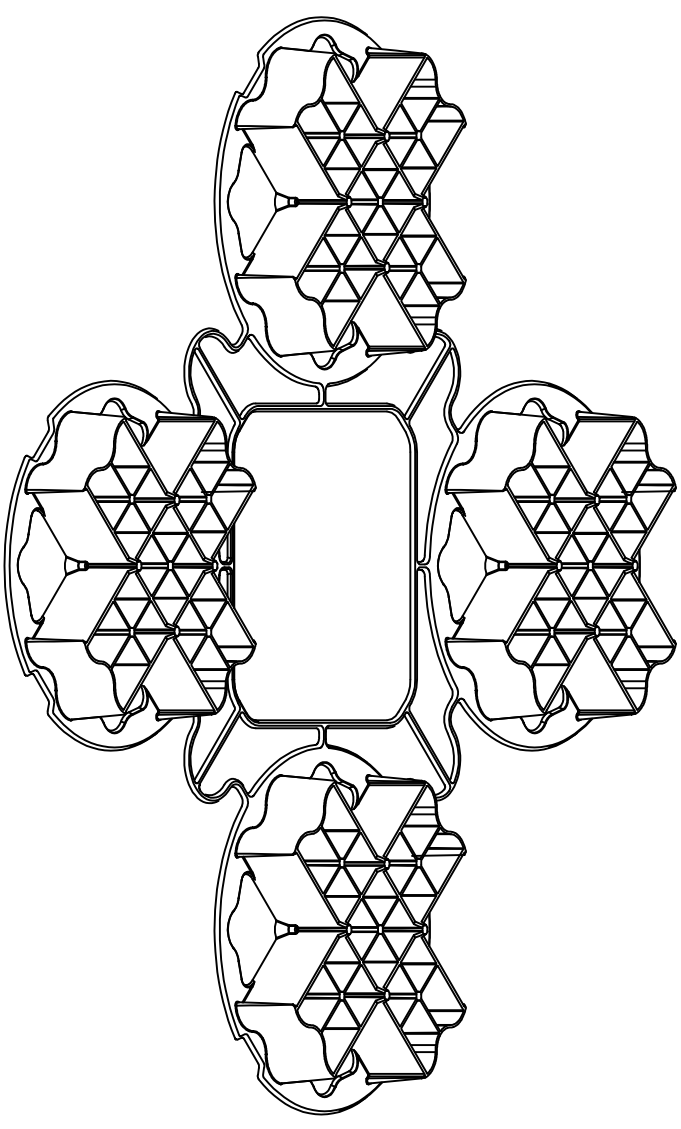
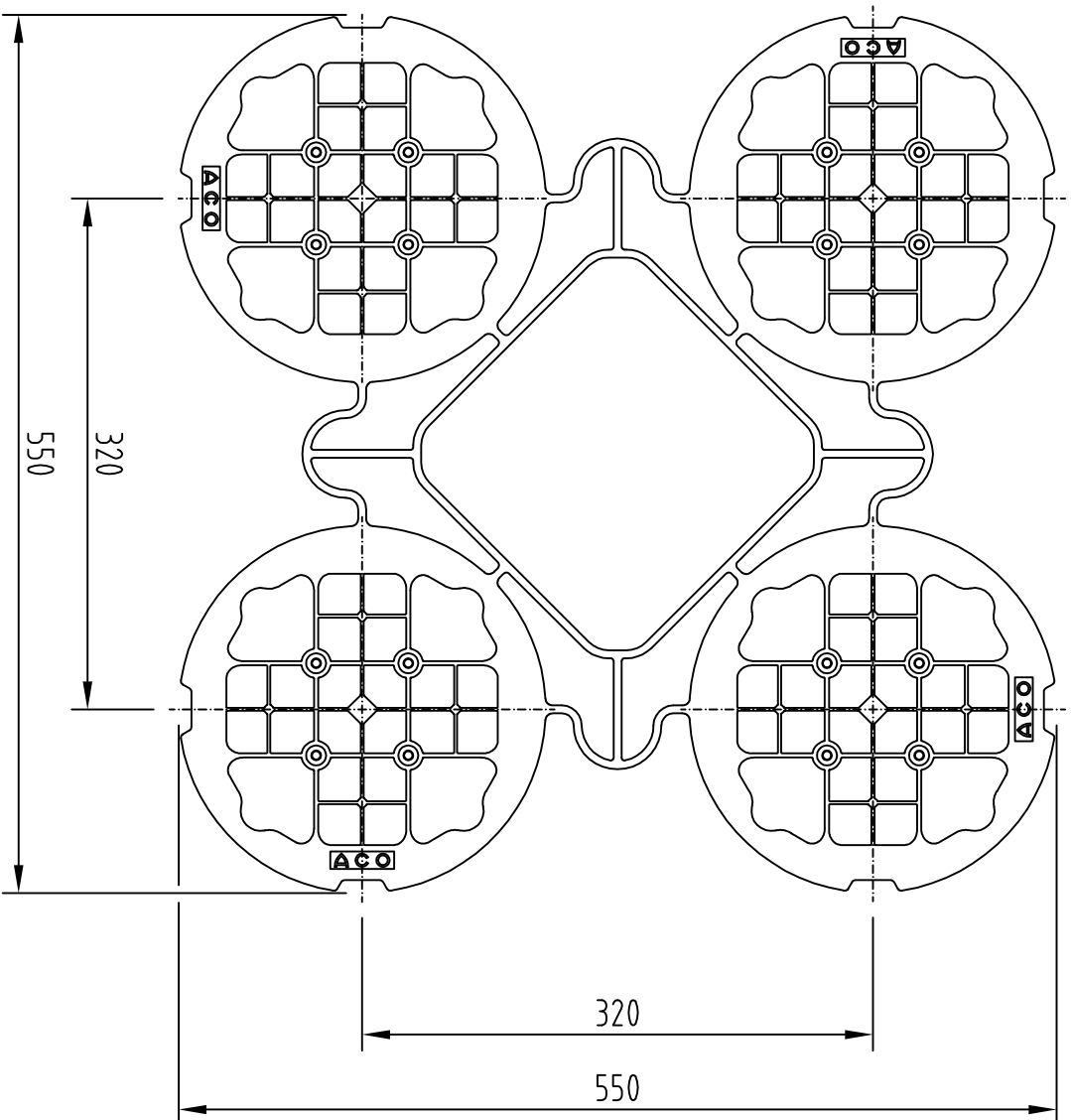

Benennung: ACO Stormbrixx 914 SD, Seiten wand 0,592 x 0,907 x 0,104 m Art.-Nr. 314.091		Datum 17.07.2017		Name hshvalin	
Technische Änderungen vorbehalten		Upd. Norm		Zeichnung-Nr. G1-M01-XXXX-X	
Schutzvermerk gemäß DIN 34		Ers. für:		ACO Tiefbau Vertrieb GmbH 21255 Rendsburg, Postfach 320 Tel. 04331 / 354-500 FAX 04331 / 354-358 www.aco-tiefbau.de	
				Index 000	



Benennung: ACO Stormbrixx 914 SD, Abdeckung 0,55 x 0,55 x 0,05 m Art.-Nr. 314092		Datum 17.07.2017		Name skarthik		 ACO Tiefbau ACO Tiefbau Vertrieb GmbH 21255 Rendburg, Postfach 320 Tel. 04331 / 354-500 Fax 04331 / 354-358 www.aco-tiefbau.de	Zeichnung-Nr. G1-M01-XXXX-X Index 000
Technische Änderungen vorbehalten		Schutzvermerk gemäß DIN 34		Ers. für:			
Gez. Upd. Norm		Datum 17.07.2017		Name skarthik			

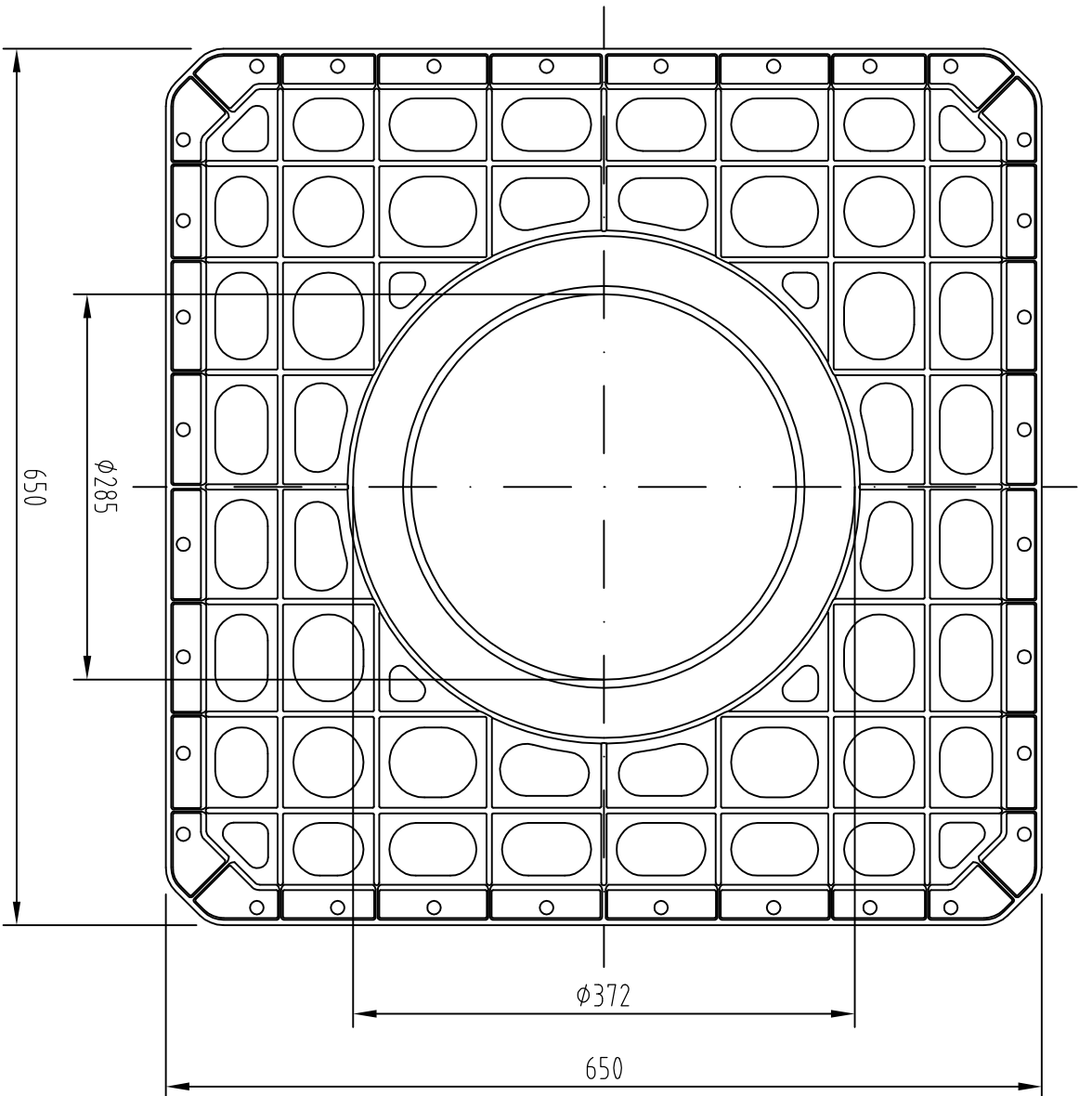
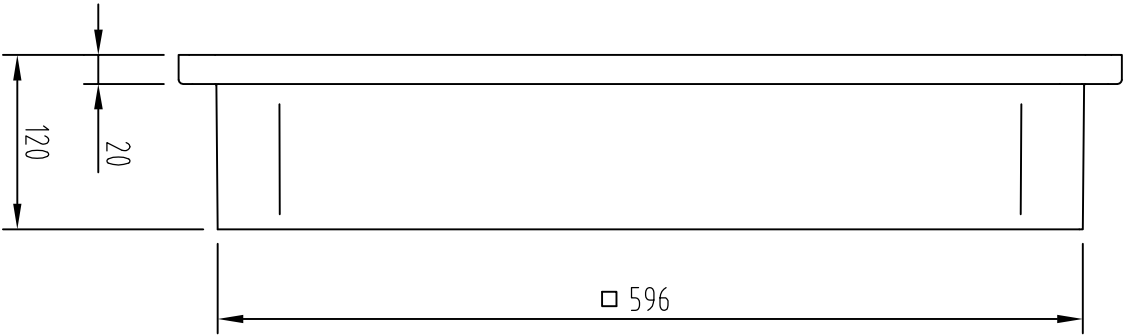
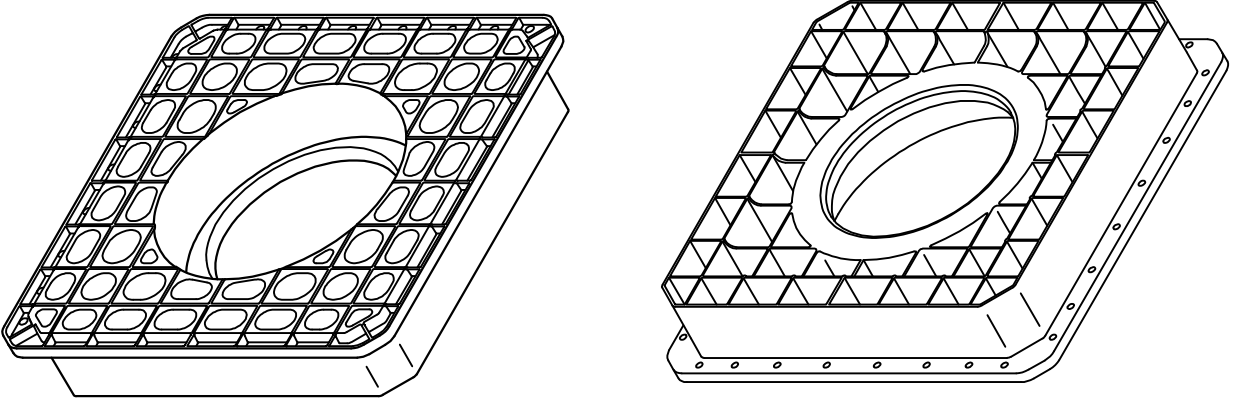

Material:
Gewicht: 4,8 kg

Benennung:
ACO Stormbrixx
Adapter für Schachtaufbau
Art.-Nr. 314083

Technische Änderungen vorbehalten

	Datum	Name
Gez.	30.08.2016	debeling
Upd	19.11.2013	debeling
Norm		

ACO Tiefbau
ACO Tiefbau Vertrieb GmbH
24555 Sandberg, Postfach 309
Tel. 04371 / 354-500
Fax 04371 / 354-358
www.aco-tiefbau.de

Zeichnung-Nr.
G1-M01-1420-3

Index
000

Schutzvermerk gemäß DIN 34

Ers. für: